

■ Features

- Plastic housing with class II design
- Built-in active PFC function
- Class 2 power unit
- Standby power consumption <0.5W
- IP67 rating for indoor or outdoor installations
- Function: 3 in 1 dimming (dim-to-off)
- Typical lifetime >50000hours
- 5 years warranty

■ Applications

- LED panel lighting
- LED downlight
- LED decorative lighting
- LED tunnel lighting
- Moving sign
- Type “HL” for use in Class I, Division 2 hazardous (Classified) location

■ Description

NPF-60D series is a 60W AC/DC LED driver featuring the constant current mode output. NPF-60D operates from 90~305VAC and offers models with different rated voltage ranging between 12V and 54V. Thanks to the high efficiency up to 90%, with the fanless design, the entire series is able to operate for -40~+85°C case temperature under free air convection. The entire series is rated with IP67 ingress protection level and is suitable to work for a variety of applications at dry, damp or wet locations. NPF-60D is equipped with the 3 in 1 dimming function so as to provide the design flexibility for LED lighting system.

■ Model Encoding

NPF - 60 D - 24

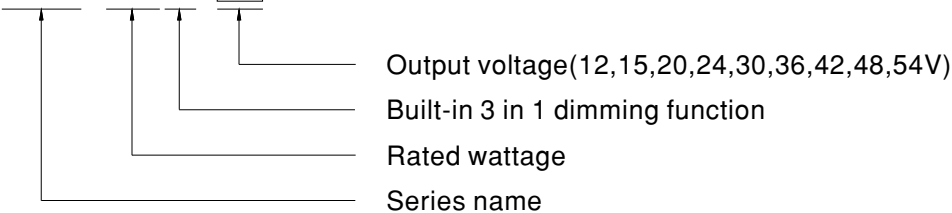

SPECIFICATION

MODEL		NPF-60D-12 □	NPF-60D-15 □	NPF-60D-20 □	NPF-60D-24 □	NPF-60D-30 □	NPF-60D-36 □	NPF-60D-42 □	NPF-60D-48 □	NPF-60D-54 □	
OUTPUT	RATED CURRENT	5A	4A	3A	2.5A	2A	1.67A	1.43A	1.25A	1.12A	
	RATED POWER	60W	60W	60W	60W	60W	60.12W	60.06W	60W	60.48W	
	CONSTANT CURRENT REGION	7.2 ~ 12V	9 ~ 15V	12 ~ 20V	14.4 ~ 24V	18 ~ 30V	21.6 ~ 36V	25.2 ~ 42V	28.8 ~ 48V	32.4 ~ 54V	
	CURRENT RIPPLE	5.0% max. @rated current									
	CURRENT TOLERANCE	±5.0%									
	SET UP TIME <small>Note.3</small>	500ms/115VAC, 230VAC									
INPUT	VOLTAGE RANGE <small>Note.2</small>	90 ~ 305VAC 127 ~ 431VDC (Please refer to "STATIC CHARACTERISTIC" section)									
	FREQUENCY RANGE	47 ~ 63Hz									
	POWER FACTOR (Typ.)	PF ≥ 0.97/115VAC, PF ≥ 0.95/230VAC, PF ≥ 0.92/277VAC@full load (Please refer to "POWER FACTOR (PF) CHARACTERISTIC" section)									
	TOTAL HARMONIC DISTORTION	THD < 20% (@load ≥ 60%/115VAC, 230VAC; @load ≥ 75%/277VAC) (Please refer to "TOTAL HARMONIC DISTORTION(THD)" section)									
	EFFICIENCY(Typ.)	86%	87%	88%	89%	90%	90%	90%	90%	90%	
	AC CURRENT (Typ.)	0.8A / 115VAC			0.4A / 230VAC			0.32A / 277VAC			
	INRUSH CURRENT(Typ.)	COLD START 50A(twidth=270μs measured at 50% Ipeak) at 230VAC; Per NEMA 410									
	MAX. NO. of PSUs on 16A CIRCUIT BREAKER	9 units (circuit breaker of type B) / 16 units (circuit breaker of type C) at 230VAC									
	LEAKAGE CURRENT	<0.25mA / 277VAC									
	STANDBY POWER CONSUMPTION	<0.5W									
PROTECTION	OVER CURRENT	95 ~ 108% Constant current limiting, recovers automatically after fault condition is removed									
	SHORT CIRCUIT	Hiccup mode, recovers automatically after fault condition is removed									
	OVER VOLTAGE	15 ~ 17V	17.5 ~ 21V	23 ~ 27V	28 ~ 34V	34 ~ 40V	41 ~ 46V	46 ~ 54V	54 ~ 60V	59 ~ 66V	
	OVER TEMPERATURE	Shut down o/p voltage, re-power on to recover									
ENVIRONMENT	WORKING TEMP.	Tcase=-40 ~ +85°C (Please refer to "OUTPUT LOAD vs TEMPERATURE" section)									
	MAX. CASE TEMP.	Tcase=+85°C									
	WORKING HUMIDITY	20 ~ 95% RH non-condensing									
	STORAGE TEMP., HUMIDITY	-40 ~ +80°C, 10 ~ 95% RH									
	TEMP. COEFFICIENT	±0.03%/°C (0 ~ 50°C)									
	VIBRATION	10 ~ 500Hz, 5G 12min./1cycle, period for 72min. each along X, Y, Z axes									
SAFETY & EMC	SAFETY STANDARDS	UL8750(type"HL"), CSA C22.2 No. 250.13-12, ENEC EN61347-1, EN61347-2-13, EN62384 independent, IP67 approved ; Design refer to EN60335-1									
	WITHSTAND VOLTAGE	I/P-O/P:3.75KVAC									
	ISOLATION RESISTANCE	I/P-O/P:100M Ohms / 500VDC / 25°C / 70% RH									
	EMC EMISSION	Compliance to EN55015, EN61000-3-2 Class C (@ load ≥ 60%) ; EN61000-3-3									
OTHERS	EMC IMMUNITY	Compliance to EN61000-4-2,3,4,5,6,8,11; EN61547, light industry level(surge immunity Line-Line 2KV)									
	MTBF	1016.1K hrs min. Telcordia SR-332 (Bellcore) ; 314.05K hrs min. MIL-HDBK-217F (25°C)									
	DIMENSION	150*53*35mm (L*W*H)									
NOTE	PACKING	0.49Kg;30pcs/15.7Kg/1.0CUFT									
	NOTE	1. All parameters NOT specially mentioned are measured at 230VAC input, rated current and 25°C of ambient temperature. 2. De-rating may be needed under low input voltages. Please refer to "STATIC CHARACTERISTIC" sections for details. 3. Length of set up time is measured at first cold start. Turning ON/OFF the driver may lead to increase of the set up time. 4. The standby power consumption is specified for 230VAC. 5. The driver is considered as a component that will be operated in combination with final equipment. Since EMC performance will be affected by the complete installation, the final equipment manufacturers must re-qualify EMC Directive on the complete installation again. 6. The model certified for CCC(GB19510.14, GB19510.1, GB17743 and GB17625.1) is an optional model . Please contact MEAN WELL for details. 7. This series meets the typical life expectancy of >50,000 hours of operation when Tcase, particularly (Tc) point (or TMP, per DLC), is about 75°C or less. 8. Please refer to the warranty statement on MEAN WELL's website at http://www.meanwell.com									

■ BLOCK DIAGRAM

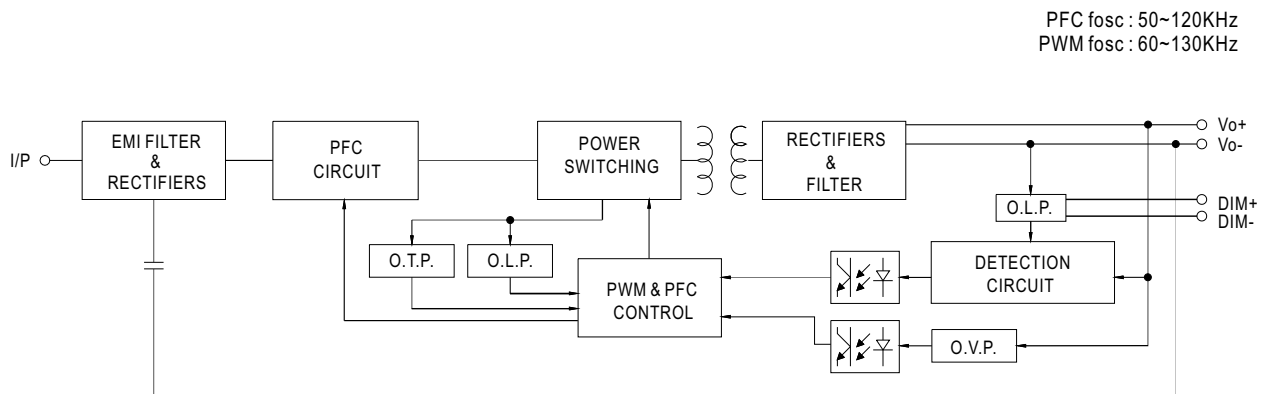

■ DRIVING METHODS OF LED MODULE

※ This series works in constant current mode to directly drive the LEDs.

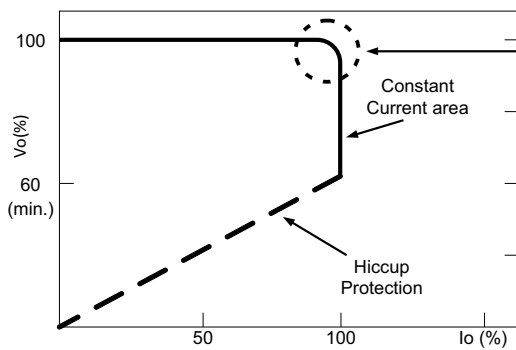

Typical LED power supply I-V curve

In the constant current region, the highest voltage at the output of the driver depends on the configuration of the end systems.

Should there be any compatibility issues, please contact MEAN WELL.

■ DIMMING OPERATION

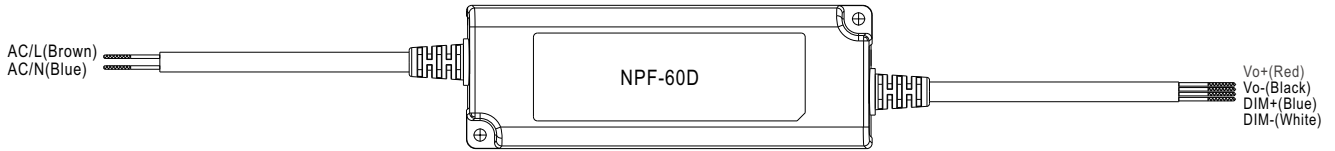

※ **3 in 1 dimming function**

- Output constant current level can be adjusted by applying one of the three methodologies between DIM+ and DIM-: 0 ~ 10VDC, or 10V PWM signal or resistance.
- Direct connecting to LEDs is suggested. It is not suitable to be used with additional drivers.
- Dimming source current from power supply: 100 μ A (typ.)

◎ Applying additive 0 ~ 10VDC

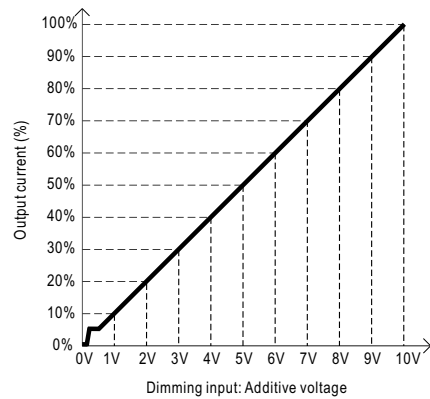
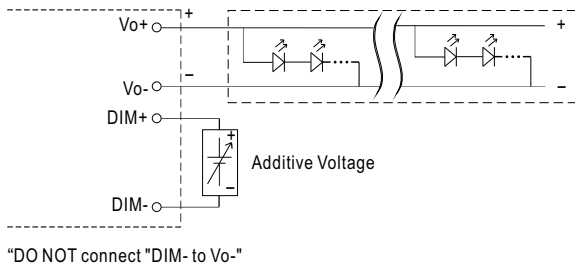

◎ Applying additive 10V PWM signal (frequency range 100Hz ~ 3KHz):

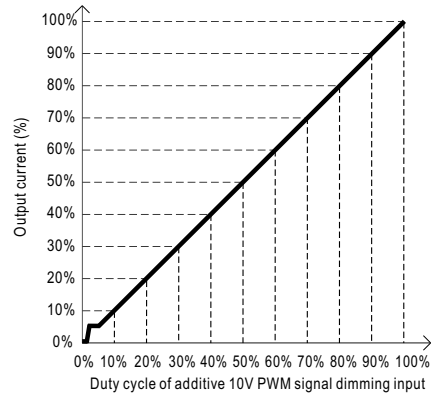
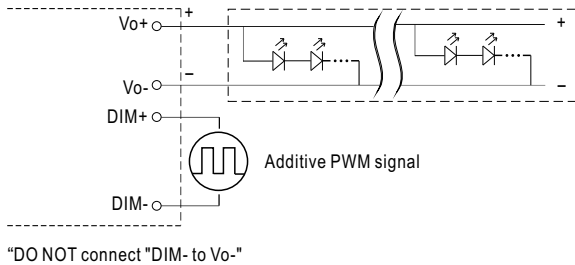

◎ Applying additive resistance:

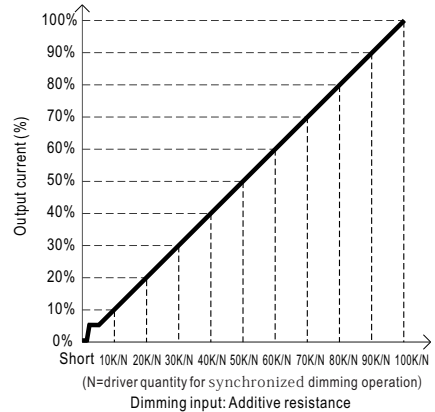
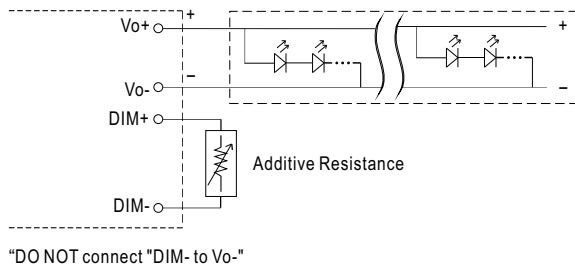

Note : 1. Min. dimming level is about 6% and the output current is not defined when 0% < Iout < 6%.
 2. The output current could drop down to 0% when dimming input is about 0k Ω or 0Vdc, or 10V PWM signal with 0% duty cycle.

OUTPUT LOAD vs TEMPERATURE

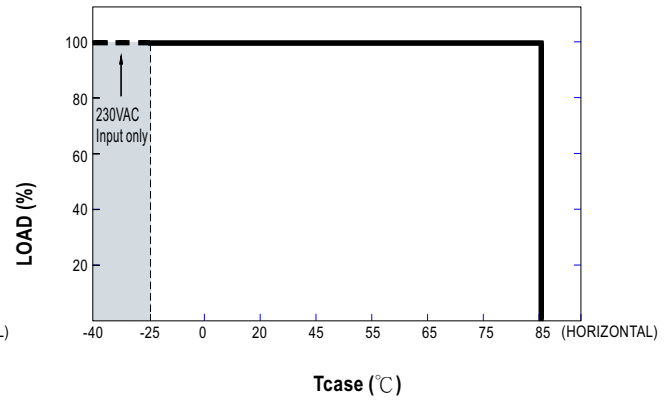
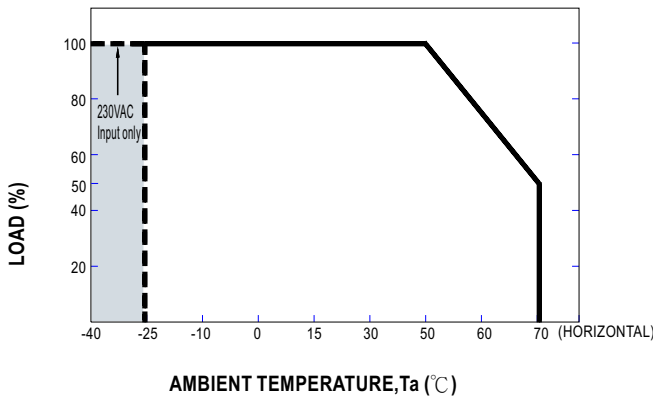

STATIC CHARACTERISTIC

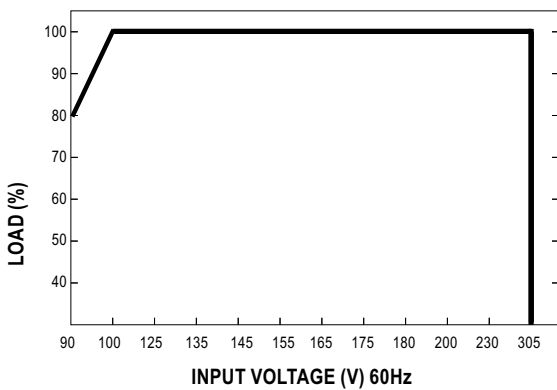

※ De-rating is needed under low input voltage.

POWER FACTOR (PF) CHARACTERISTIC

※ Tcase at 75°C

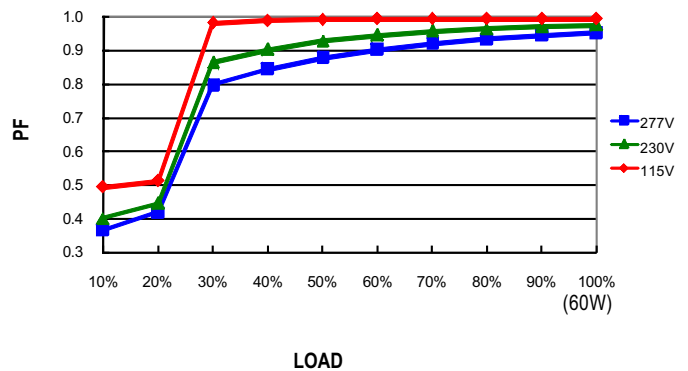

TOTAL HARMONIC DISTORTION (THD)

※ 48V Model, Tcase at 75°C

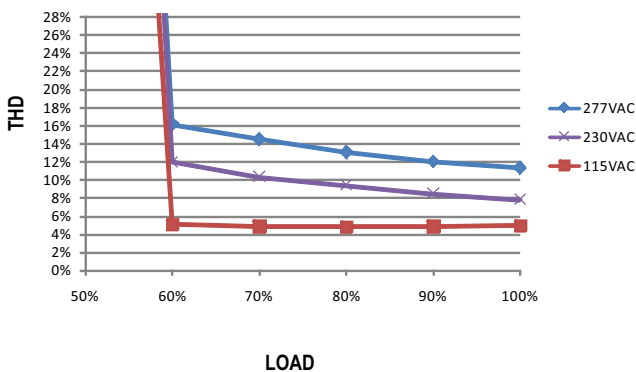

EFFICIENCY vs LOAD

NPF-60D series possess superior working efficiency that up to 90% can be reached in field applications.

※ 48V Model, Tcase at 75°C

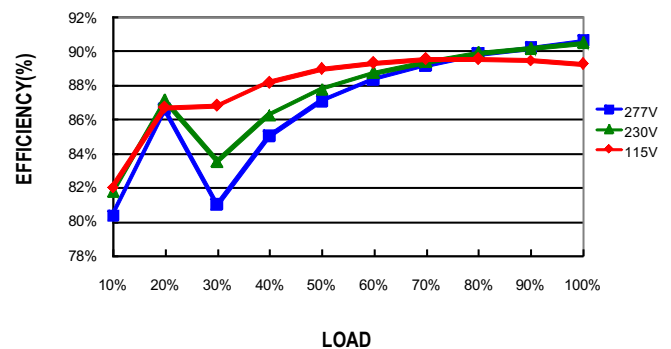

■ LIFE TIME

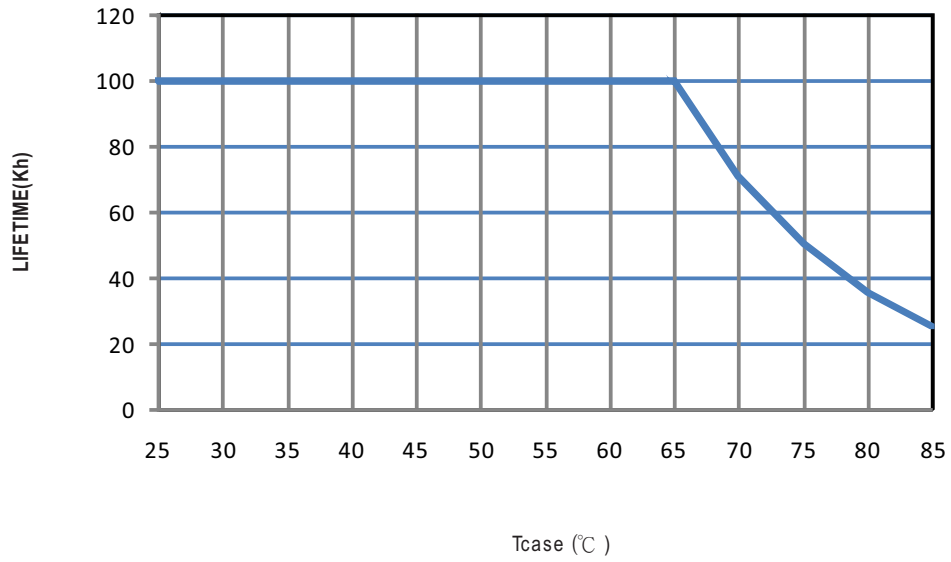

MECHANICAL SPECIFICATION

Case No. NPF-60A

Unit:mm

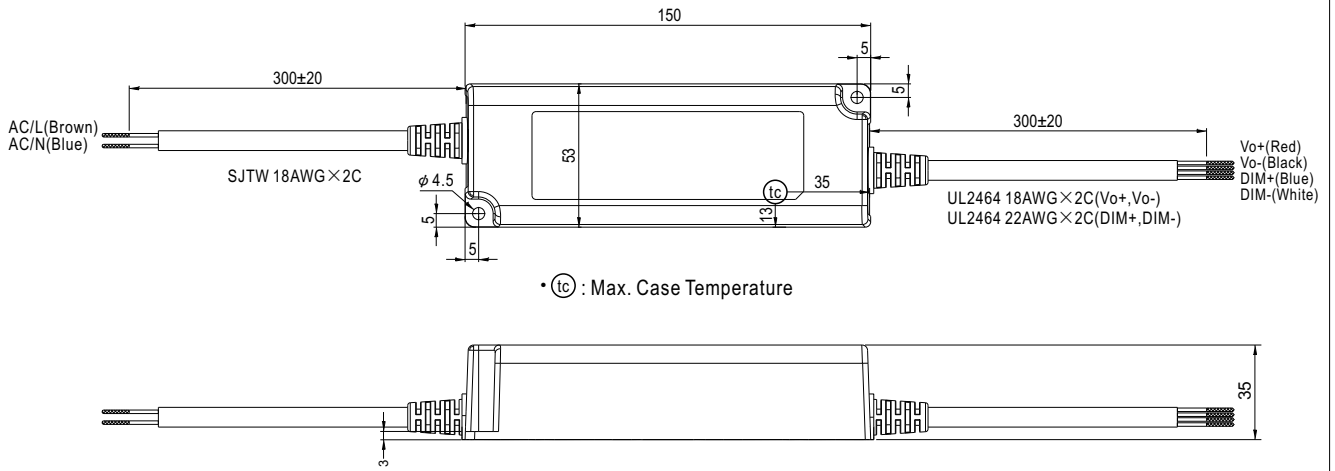

INSTALLATION MANUAL

Please refer to : <http://www.meanwell.com/webnet/search/InstallationSearch.html>